



LED Garage Canopy

Model :SZ-CNP100/80/60W-H-ACP

Advantage:

- UL & DLC certificate;
- IP65 Internal driver;
- Adjustable Power and CCT;
- Input voltage 120-277VAC;
- No UV or IR in the beam;
- Easy to install and operate;
- Energy saving, long lifespan;
- Light is soft and uniform, safe to eyes;
- Instant start, NO humming;
- Green and eco-friendly without mercury.



Application:

This garage lamp is a special design for Application in places like parking garage, Car port, driveway, underpass, etc.

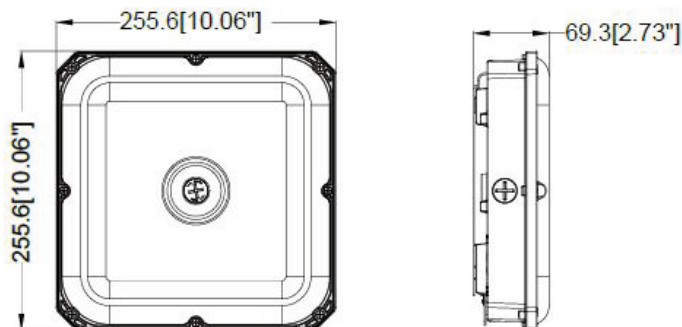

Specifications

Product name	LED Garage Canopy
Part No	SZ-CNP100/80/60W-H-ACP
Dimension	10.06*10.06*2.73"

Technical Characteristic

Color temperature	Adjustable CCT:3500K/4000K/5000K
CRI	>80
Lumen	13500LM
Lumen Efficacy	135LM/W
Input Power	Adjustable Power:100W/80W/60W
Viewing Angle	120 Degree
Input Voltage	120-277VAC 50/60Hz
Driver model	China Brand Driver, (0-10Vdc Dimmer, Surge-protective 6KV)
Photocell	Yes
PF	>0.9
Waterproof Rating	IP65

Materials

LED Type	2835
LED QTY	288PCS
Housing	Aluminum(ADC12) +PC
Housing color	Brown

Others

Operating Temperature	-40°C TO 45°C
Operating Humidity	20%-90% RH
Storage Temperature	-40°C TO 80°C
Storage Humidity	10%-95%
Application	Outdoor / Indoor
Safety Certification	UL & DLC
Warranty Time	5 Years

Light Distribution Testing Parameters

LUMINAIRE PHOTOMETRIC TEST REPORT

Test:U:119.92V I:0.7959A P:95.212W PF:0.9976 Freq:60.01Hz		
UTHDi:0.45% ITHDi:4.10% KDisp:1.000 Lamp Flux:12551.5x1 lm		
NAME: SZ-CNP100/80/60W-H-ACP	TYPE: SZ-CNP100/80/60W	WEIGHT:
SPEC.: 120~277V	DIM.: 250*250	SERIAL No.: 01
MFR.: EVERFINE	SUR.: 250*250	Shielding Angle:

DATA OF LAMP		PHOTOMETRIC DATA				Eff: 131.83 lm/W
MODEL	SZ-CNP100/80/60W	I _{max} (cd)	3129	S/MH(C0/180)	1.63	
NOMINAL POWER (W)	100	LOR (%)	100.0	S/MH(C90/270)	1.61	
RATED VOLTAGE (V)	120	TOTAL FLUX (lm)	12551	η UP, DN (C0-180)	1.7, 47.6	
NOMINAL FLUX (lm)	12551.5	CIE CLASS	DIRECT	η UP, DN (C180-360)	1.8, 48.8	
LAMPS INSIDE	1	η up (%)	3.5	CIBSE SHR NOM	1.50	
TEST VOLTAGE (V)	120	η down (%)	96.5	CIBSE SHR MAX	1.55	

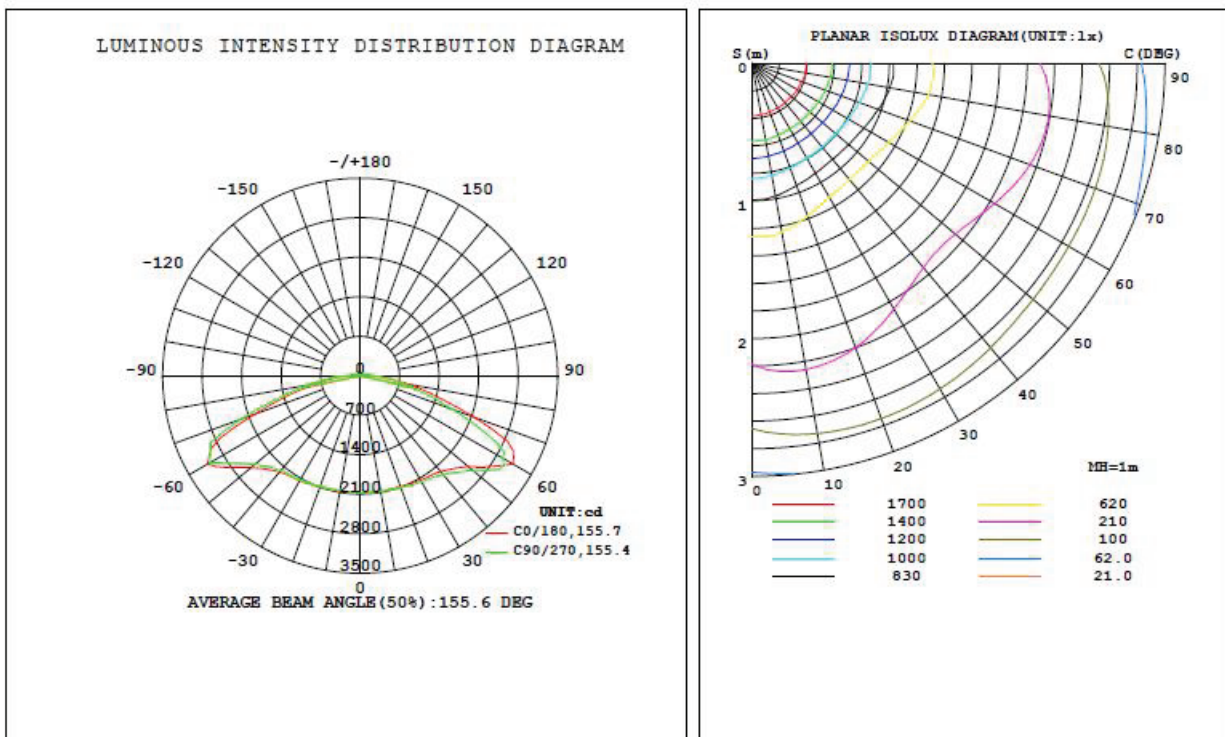

Package

Model	Net Weight	Size	Qty/Carton	Weight/Carton
SZ-CNP100/80/60W-H-ACP	9KG	15.59*12.24*12.24"	4	10.25KG

Installation Instruction

Ceiling Installation

1. Loosen the screw to take off the mounting plate from the lamp.

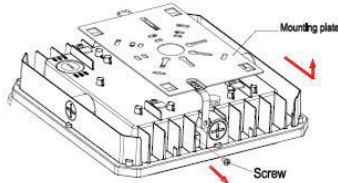

2. Screw the mounting plate to the ceiling.

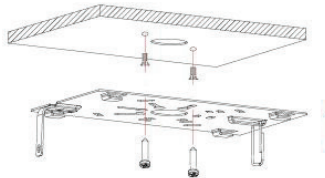

3. Hang the lamp on the ring so as to connect wires with terminal caps.

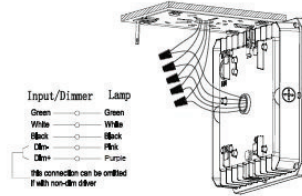

4. Hook up lamp on the mounting plate.



5. Secure the screw. Installation completed.

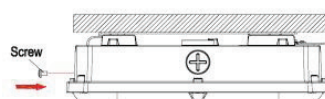

Pole-pendant Installation

1. Connecting wires with terminal caps as picture shows.

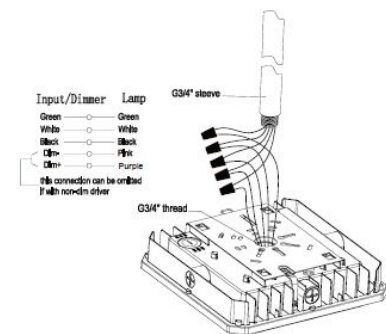

2. Rotating the steeve to make it fixed with lamp. Installation completed.

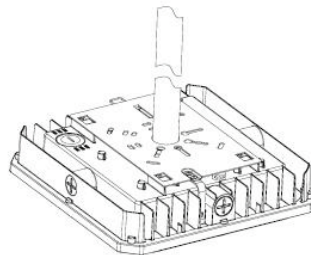

Plug sensor installation

1. Unscrew the PC cap on the lampshade counter-clockwise with a flat-head screwdriver on the lamp which already installed.

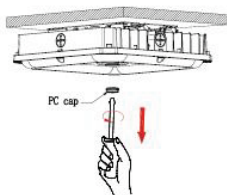

2. Screw the sensor clockwise by hands.

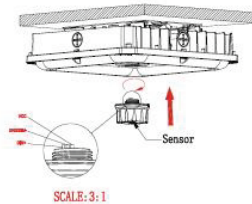

3. After tighten the sensor, lighting the lamp, if the sensor works well, the installation finish.

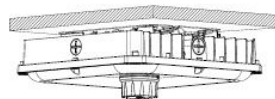

Function of CCT and power Selective

1. Before installation, unscrew the M25 cap counter-clockwise at the back of the lamp by slot type screwdriver.

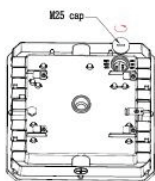

2. According to the tags, customer can select the corresponding power and CCT dip switch, dial to the required power (40w/60w/90w) and CCT (35K/40K/50K).

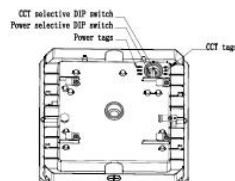

3. After finish the requires power and CCT adjustment, Tighten the M25 cap clockwise by slot type screwdriver.

