

High Mast Roadway and Area Lighting



Applications

Outdoor / Indoor / Industrial

- Sports & Recreational fields
- Large-scale outdoor events
- Industrial and Construction sites
- Parking lots and Garages
- Crane lighting
- Security and Outdoor surveillance



Sports Complex

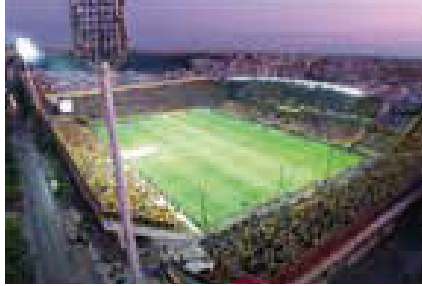

Football Pitch



Industrial & Construction Sites

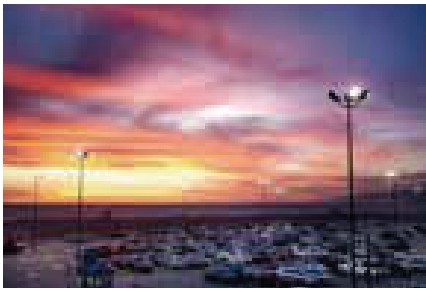

Parking Lot

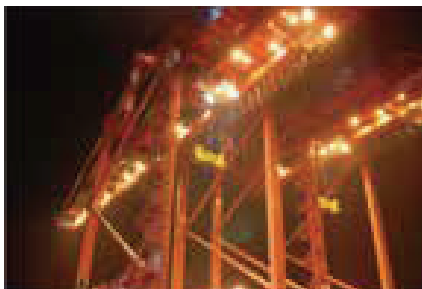

Port Lighting

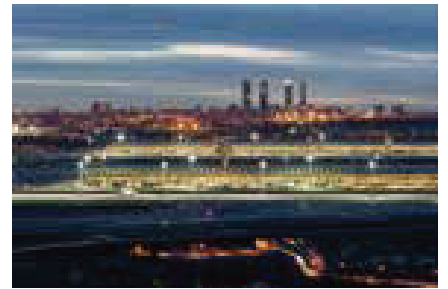

Airport

Dimension (mm/ in)

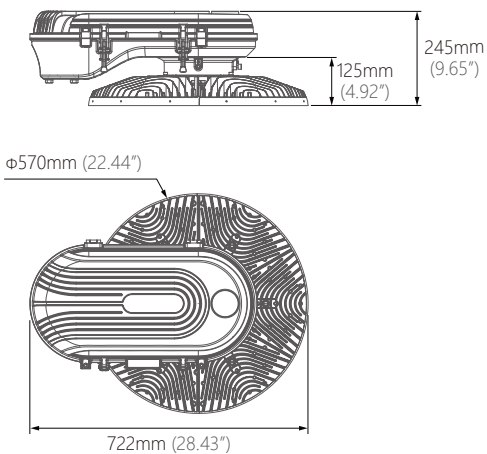

Photometric Diagrams

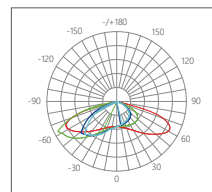

T2

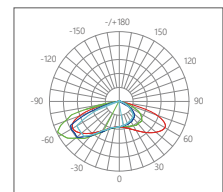

T3

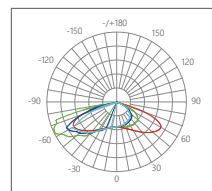

T4

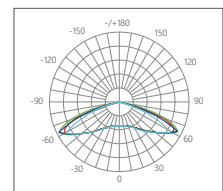

T5

Modular Design

Combined with (4/ 6/ 7) LED modules, and equipped with a glass/PC lens for each module, our High Mast Light can converge stray light most efficiently. Every single module is placed in a completely ventilated aluminum housing for maximum thermal transmission. The heat sink is made up of two pieces of die-casting aluminum for thermal convection, there are two screw bolts and buckles to fix the light when assembling and can be opened in 110 degrees.



Best Light Control

Prismatic glass optics provide high application efficiency, uniformity, and glare control.



1:1 Replacement 2000W HPS

Lumen packages ranging from 45,000 to 150,000 provide one-for-one replacement of up to 2000 watt HPS.

ENERGY SAVINGS

Energy Savings	60%
Maintenance Savings	60%
Service Life	>100,000Hours



Fit for round Pole within 42-60mm.

Reliability and Long Lifespan

Long system life with driver life exceeding 100,000 hours and LED life of L82 @100,000 hours minimize maintenance costs. Robust mechanical design with IP66 optics, 3G vibration rating, 4-bolt mounting, and a polyester paint finish with a 1,000-hour salt fog rating ensures system reliability.

Roi-Oriented

Robust extreme surge protection rating of 20KA/ 10KA. Control options include 0-10V dimming, 7-Pin photocontrol, ROAMTM enabled Field-adjustable output allows for zone control, accelerating your return on investment



For Roadway Lighting

The luminaire has multiple roadway lighting distributions designed to maximize spacing while meeting stringent requirements of IES RP8 guidelines for average, uniformity, and veiling luminance. Installation costs are minimized with this direct retrofit luminaire without rewiring or changing existing luminaire arms. Asymmetric distributions are easily aimed toward the roadway with the rotatable optical assembly.



Ventilation Convection Housing

The luminaire uses a die-casting heat sink to convect/ conduct heat, quickly dissipate heat, and extend the life of the LED lamp.

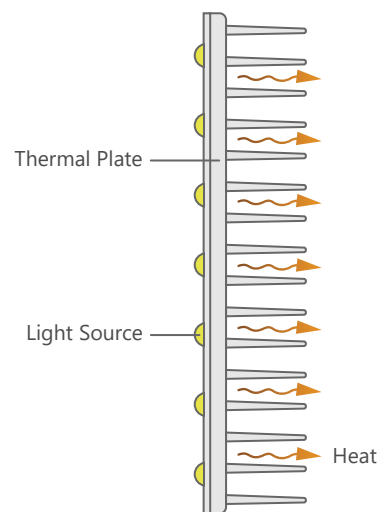

Parameters

Model No.	SZ-HML 300W/ 450W/ 600W/ 750W/ 900W/ 1000W
Wattage	300W/ 450W/ 600W/ 750W/ 900W/ 1000W
Light Efficiency	145-150Lm/W
CCT	3000K / 4000K / 5000K / 5700K / 6500K
Beam Angle	T2 / T3 / T4 / T5
CRI	70
SDCM	<5
Input Voltage	AC100-277V , AC200-480V
Power Factor	0.9
THD	<20%
Percent Flicker (%)	<1%
Surge Protection	10KV / 20KV Optional
Protection Against Electric	Class I
IP	IP66 Water-proof (<i>Wet location</i>)
IK	IK08
EPA	3.877 ft ²
Operating Temp Range	-40°C ~ +50°C @Outdoor / (-40°F ~ +122°F @Outdoor)
Intelligent Control	0-10V Dimming, DALI
Lifetime	100, 000H (L70B50 @25°C) / 100, 000H (L70B50 @77°F)
Net Weight (kg/ lbs)	22.5 kg±0.5 / 49.6 lbs±1.1
Dimension (mm/ in)	722x 570x 245mm / 28.43x 22.44x 9.65in
Packing Dimension (mm/ in)	880x 665x 350mm / 34.6x 26.19x 13.78in
Warranty	5 Years
Certificate	UL / CUL / CE / ENEC / RoHS
Specification	LED: Lumileds Driver: Inventronics, Moso
Material	Structure: Die-casting/ High Thermal Conductivity AL Finish: Powder Coated Lens: Polycarbonate/ Glass Color: Gray