

PARKING LOT LIGHT



Specifications

Construction:

- The rugged, one-piece die-cast aluminum housing features a complete heat sink that optimizes heat dissipation through convection cooling management.
- Low profile, 3G vibration rated compact design minimizes wind load requirements.
- Housing is completely sealed against moisture and environmental contaminants.

Optics:

- Available in IES Type II, III, IV, V distributions
- Light engines are available in adjustable color temperature (4000K&5000K&6500K) configurations.
- Scalable Lumen Packages from 6,600 to 64,000 Lumens replaces up to 7500W Metal Halide.
- Optics is precisely designed to shape the distribution, maximizing efficiency and application spacing.
- The optics can conform to dark sky requirement.

Electrical:

- Universal 120-277 VAC or 277-480 VAC input voltage
- 6KA(@120-277V) and (@277-480V) surge protection
- 0-10V dimming driver standard for 10% to 100% dimming
- Power adjustable.
- THD: ≤20%
- Power Factor: ≥90%

Sensor:

- Optional Microwave sensor or Photocell sensor.

Ambient Temperature:

- Ambient operating temperature -40°C to 45°C (-40°F to 113°F).

Installation:

- Suitable for mounting heights ranging from 26-50' in area lighting applications
- Round pole, Square pole, Slipfitter, Wall mount and Yoke are available.
- The design can be operated by one person to install the whole lamp

Lifespan:

- Estimated 100,000-hour LED lifespan based on IES LM-80 results and TM-21 calculations



Certifications:

- UL wet location listed
 - DesignLights Consortium™ Qualified for Outdoor Pole/Arm-Mounted Area and Roadway Luminaires, Architectural Flood and Spot Luminaires.
- Note: DesignLights Consortium™ Qualified and classified for DLC Premium, refer to www.designlights.org for details.

Note:

Actual performance may differ as a result of end-user environment and application. All values are design or typical values, measured under laboratory conditions at 25°C (±5°C) specifications subject to change without notice.



Finish:

- Standard: Dark Bronze
- Optional: Black, Silver Gray, White, Custom Color.

Structural Design

Housing

The one-piece die-cast housing with corrosion-resistant coating protection and the modular design extend the life of the luminaire while making it easy to maintain.

CCT & POWER Adjustable

Offer three selectable lumen outputs, and three selectable CCTs (4000K/5000K/6500K)



POWER	CCT
LV1	40K
LV2	50K
LV3	65K

Photometry

Optional Type II, Type III, Type IV and Type V Photometry as per applications.

Mounting

Optional for square, round pole mount, slipfitter, wall mount, yoke mount. All mounting brackets are simple to operate, which can realize single operation and reduce labor costs.

Sensor Base

Optional headphone jack sensor, Photocell and Microwave Sensor, security and energy saving.

Respirator

The respirator helps with heat dissipation, temperature resistance, and pressure balancing. It improves the reliability of the product in harsh environments and prolongs product life.

PERFORMANCE DATA

150W									
SETTING	SYSTEM WATTS	DIST.TYPE	CRI	4000K		5000K		6500K	
				LUMENS	LPW	LUMENS	LPW	LUMENS	LPW
100%	150W	2	70	20000lm	130 lm/W	22000lm	150 lm/W	20000lm	130 lm/W
		3	70	20000lm	130 lm/W	22000lm	150 lm/W	20000lm	130 lm/W
		4	70	20000lm	130 lm/W	22000lm	150 lm/W	20000lm	130 lm/W
		5	70	20000lm	130 lm/W	22000lm	150 lm/W	20000lm	130 lm/W
67%	100W	2	70	14000lm	140 lm/W	16000lm	160 lm/W	14500lm	145 lm/W
		3	70	14000lm	140 lm/W	16000lm	160 lm/W	14500lm	145 lm/W
		4	70	14000lm	140 lm/W	16000lm	160 lm/W	14500lm	145 lm/W
		5	70	14000lm	140 lm/W	16000lm	160 lm/W	14500lm	145 lm/W
47%	70W	2	70	10500lm	150 lm/W	11500lm	165lm/W	11000lm	155 lm/W
		3	70	10500lm	150 lm/W	11500lm	165lm/W	11000lm	155 lm/W
		4	70	10500lm	150 lm/W	11500lm	165lm/W	11000lm	155 lm/W
		5	70	10500lm	150 lm/W	11500lm	165lm/W	11000lm	155 lm/W

300W									
SETTING	SYSTEM WATTS	DIST.TYPE	CRI	4000K		5000K		6500K	
				LUMENS	LPW	LUMENS	LPW	LUMENS	LPW
100%	300W	2	70	40000lm	130 lm/W	45000lm	150 lm/W	41000lm	135lm/W
		3	70	40000lm	130 lm/W	45000lm	150 lm/W	41000lm	135lm/W
		4	70	40000lm	130 lm/W	45000lm	150 lm/W	41000lm	135lm/W
		5	70	40000lm	130 lm/W	45000lm	150 lm/W	41000lm	135lm/W
80%	240W	2	70	34000lm	140 lm/W	37000lm	154 lm/W	35000lm	145lm/W
		3	70	34000lm	140 lm/W	37000lm	154 lm/W	35000lm	145lm/W
		4	70	34000lm	140 lm/W	37000lm	154 lm/W	35000lm	145lm/W
		5	70	34000lm	140 lm/W	37000lm	154 lm/W	35000lm	145lm/W
67%	200W	2	70	28000lm	145lm/W	31000lm	160 lm/W	30000lm	150lm/W
		3	70	28000lm	145lm/W	31000lm	160 lm/W	30000lm	150lm/W
		4	70	28000lm	145lm/W	31000lm	160 lm/W	30000lm	150lm/W
		5	70	28000lm	145lm/W	31000lm	160 lm/W	30000lm	150lm/W

BUG @5000K

SYSTEM WATTS	VOLTAGE	DIST.TYPE	B	U	G
150W	120-277V/277-480V	2	3	0	3
		3	3	0	3
		4	3	0	3
		5	5	0	5
300W	120-277V/277-480V	2	4	0	4
		3	4	0	4
		4	5	0	4
		5	5	0	5

ELECTRICAL DATA

Number Of Drivers	Driver Current (mA)	Nominal Power (W)	INPUT VOLTAGE (V)	CURRENT (Amps)
1	750	150	120	1.375
		150	208	0.793
		150	240	0.687
		150	277	0.595
		150	347	0.475
		150	480	0.343
1	1500	300	120	2.75
		300	208	1.586
		300	240	1.375
		300	277	1.191
		300	347	0.951
		300	480	0.687

MOUNTING

- Standard versatile mounting arm accommodates multiple drilling patterns as well as square and round poles
- Optional for cast aluminum slipfitter mounting adapter

Mounting Options



Slipfitter Mount: SZ-AM
An optional cast aluminum mast arm adapter secures fixture head to nominal 2-3/8" O.D. horizontal steel tenon arm.



DM Mount: SZ-DM
(4" and 5" Square and Round poles)
Standard versatile mounting arm is simple to install and can be used with existing poles for retrofit installations.

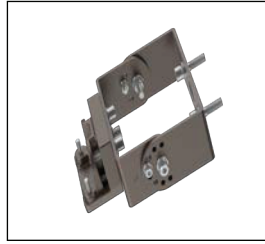

Yoke Mount: SZ-YM
Die-cast aluminum trunion is easily adapted to many surfaces and allows easy fixture aiming angles.

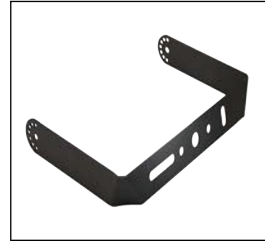

U Shaped Mount: SZ-UM
Can be converted into a floodlight

Mounting Dimensions

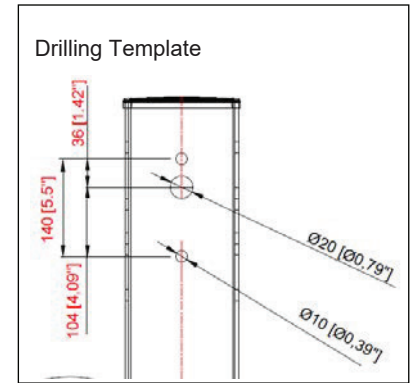
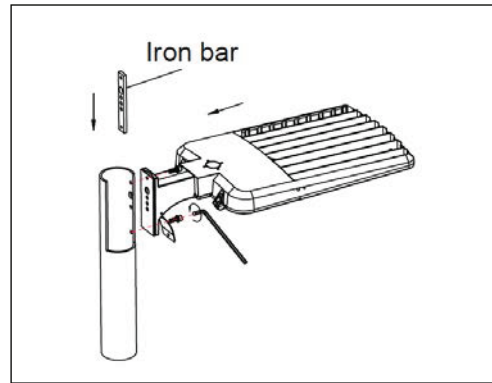
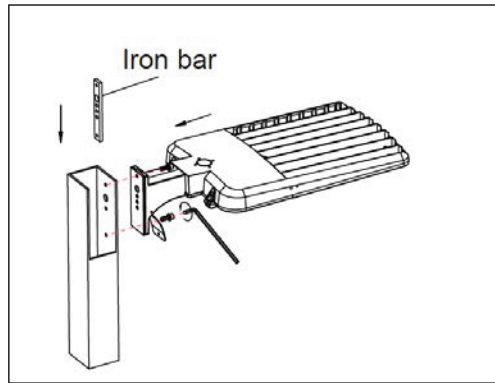

DIMENSION

unit: inch/mm



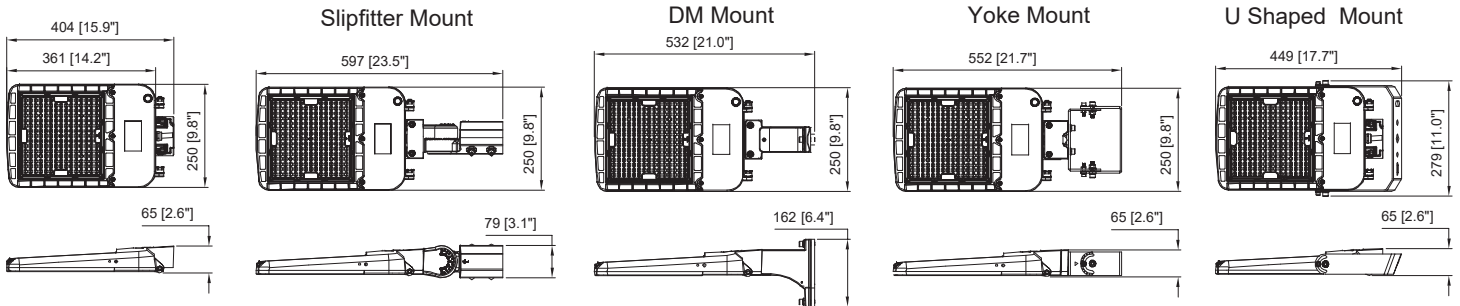

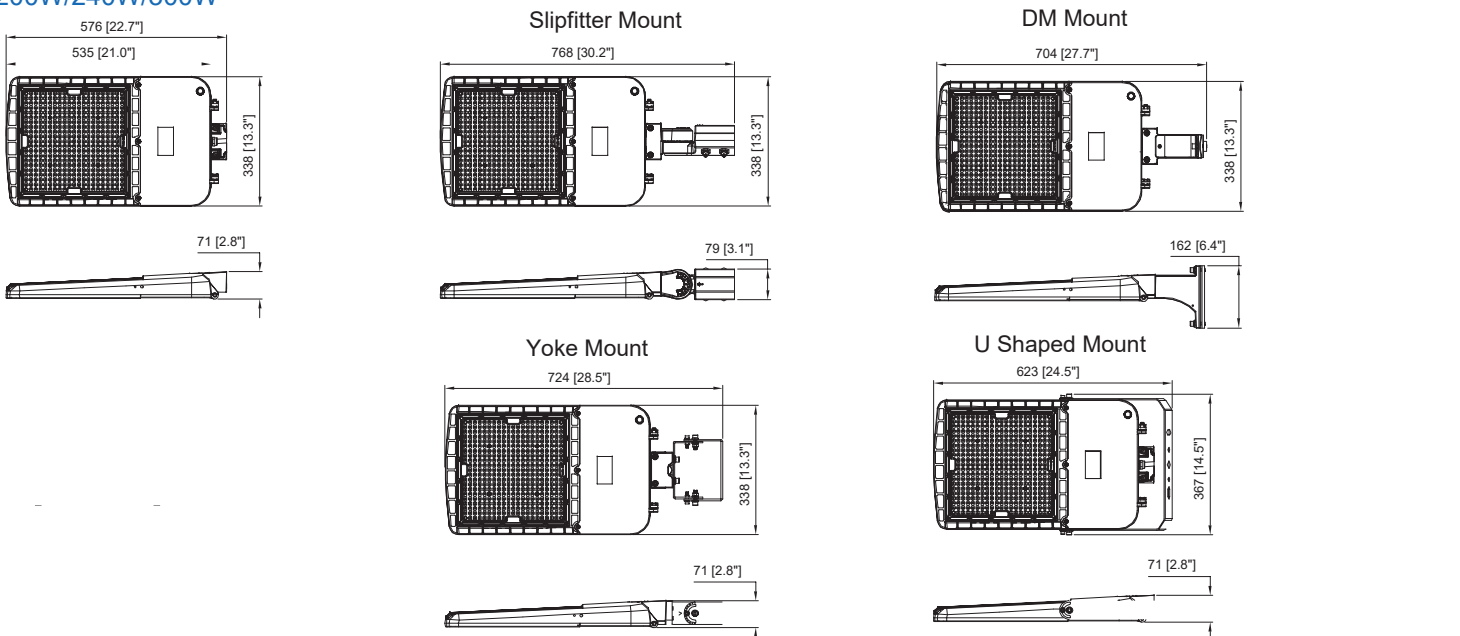

70W/100W/150W



200W/240W/300W

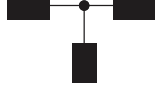
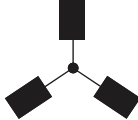

EPA OF AREA LIGHT

Item							
	1	2 @90°	2 @120°	2@180°	3 @90°	3 @120°	4 @90°
70W/100W/150W	0.3632	0.6849	0.8861	0.7264	1.0481	1.2078	1.0481
200W/240W/300W	0.4758	0.8091	1.059	0.9516	1.2849	1.3923	1.2849

PHOTOMETRICS

SZ offers a complete set of optical systems to meet every site lighting requirement. These systems provide remarkable flexibility in precisely matching light distribution patterns to specific site requirements.

Type 2 optics are ideal for applications where there is a need to space the luminaires farther apart along a road or pathway. The light distribution pattern is optimized for elongated areas, allowing for greater pole spacing without sacrificing lighting quality.

Type 3 optics produce an asymmetrical pattern that directs the majority of the light forward and equally on both sides of the luminaire. In a back-to-back configuration, it creates a rectangular pattern which can extend pole spacings.

Type 4 is suitable for applications where light is primarily required forward with minimal backlight. Typical installations include perimeter poles.

Type 5 optics produce a symmetrical square distribution pattern that distributes light equally on all sides of the luminaire. Type 5 luminaires is universal for most area lighting applications

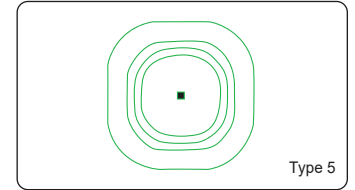
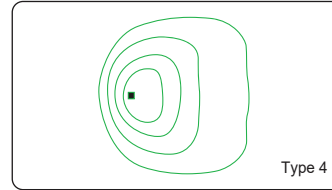
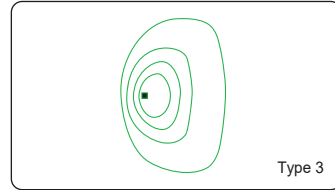
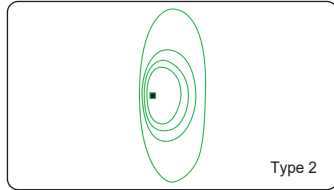

ORDERING GUIDE Example: SZ-PK150W-H1H-ACP





Company Code	Fixture Type	Wattage	High Efficiency	Voltage	Sensor (optional)	CCT Kelvin
<input type="text"/>	<input type="text"/>	<input type="text"/>	<input type="text"/>	<input type="text"/>	<input type="text"/>	<input type="text"/>
SZ Company Name	PK Parking Lot	150W 300W	H1 High Efficiency	Blank 120-277V H 277-480V	Blank Without Photocell/Sensor MS Motion Sensor (option) P Photocell (option)	CCT Single CCT: 4000K, 5000K, 6500K (specify) ACP Adjustable CCT and Power 150W: 70/100/150W 4000K/5000K/6500K 300W: 200/240/300W 4000K/5000K/6500K

ACCESSORIES(Optional)





PK series features a backlight control which provides reduced pixilation and increased visual comfort without compromising performance. External Glare Shield: sold separately or as an accessory.

			
SZ-PKXW-Cover			

Sensor (Optional)

			
SZ-MS-MH1 Plug-and-Play Microwave and Photocell Sensor	SZ-PS-A Plug-and-Play Photocell Sensor	SZ-MS-MH1K5 Plug-and-Play Microwave and Photocell Sensor, 5 Manual Switches, easy programming	SZ-MS-RC1 Sensor Remote

ADDITIONAL MOUNTING ACCESSORIES

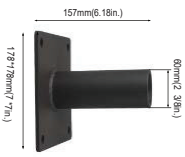
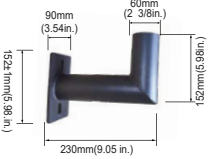
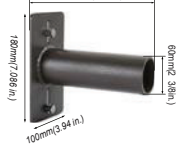
POLE BRACKET		• For mounting one fixture on an existing pole • Pole adaptor for tenon mounts	
	<p>4\" Square Pole Mount with 2-3/8\" O.D. Tenon No. SZ-4S1 Finish: Dark Bronze USE: For use with square, non-tapered steel and aluminum poles. Furnished with eight M8 hex head stainless-steel bolts. Vertical tenon measures 2-3/8\" O.D., Fixtures mounted to this bracket can be adjusted both vertically and horizontally.</p>		<p>4\" Round Pole Mount with 2-3/8\" O.D. Tenon NO. SZ-4R-1R Finish: Dark Bronze USE: For use with Round, non-tapered steel and aluminum poles. Furnished with six 3/8\" hex head stainless-steel bolts. Vertical tenon measures 2-3/8\" O.D., Fixtures mounted to this bracket can be adjusted both vertically and horizontally.</p>
	<p>5\" Square Pole Mount with 2-3/8\" O.D. Tenon No. SZ-5S1 Finish: Dark Bronze USE: For use with square, non-tapered steel and aluminum poles. Furnished with eight M8 hex head stainless-steel bolts. Vertical tenon measures 2-3/8\" O.D., Fixtures mounted to this bracket can be adjusted both vertically and horizontally.</p>		<p>5\" Round Pole Mount with 2-3/8\" O.D. Tenon NO. SZ-5R-1R Finish: Dark Bronze USE: For use with Round, non-tapered steel and aluminum poles. Furnished with eight 3/8\" hex head stainless-steel bolts. Vertical tenon measures 2-3/8\" O.D., Fixtures mounted to this bracket can be adjusted both vertically and horizontally.</p>
WALL BRACKET		Mid-Pole tenon Bracket	
	<p>90\" Wall Mount Bracket with 2-3/8\" O.D. Tenon NO. SZ-P3 Finish: Dark Bronze USE: The 90\" wall mount bracket with 2-3/8\" tenon attaches an SZ Parking lot light to almost any surface: wall, roof, or wood pole. Provides wiring access and a built-in 2-3/8\" O.D. Mounting holes are spaced 5.9\" apart.</p>		<p>2-3/8\" OD Horizontal Tenon Mid-Pole Bracket NO. SZ-P1 Finish: Dark Bronze USE: 2-3/8\" OD Horizontal Tenon Mid-Pole Bracket is designed to mount light fixture that is equipped with an adjustable slipfitter onto a 2-3/8\" OD horizontal tenon, Mounting holes are spaced 5.63\" apart.</p>
	<p>90\" Wall Mount Bracket with 2-3/8\" O.D. Tenon NO. SZ-P4 Finish: Dark Bronze USE: The 90\" wall mount bracket with 2-3/8\" tenon attaches an SZ Parking lot to almost any surface: wall, roof, or wood pole. Provides wiring access and built-in 2-3/8\" O.D. Mounting holes are spaced 4\" apart.</p>		<p>2-3/8\" OD Horizontal Tenon Mid-Pole Bracket NO. SZ-P2 Finish: Dark Bronze USE: 2-3/8\" OD Horizontal Tenon Mid-Pole Bracket is designed to mount light fixture that is equipped with an adjustable slipfitter onto a 2-3/8\" OD horizontal tenon, Mounting holes are spaced 3.18-5.63\" apart.</p>