

### LED Sport Light

Model: SZ-SP600WH-25-5000K

#### Advantage:

- UL certificate
- 5050 Chip
- Input voltage 277-480VAC
- No UV or IR in the beam
- Easy to install and operate
- Energy saving, long lifespan
- Light is soft and uniform, safe to eyes
- Instant start, NO flickering, NO humming
- Green and eco-friendly without mercury.



#### Application:

Gymnasium, Square plaza,  
Shipyard, Airport, Wharf,  
High mast and Contour lighting, etc.

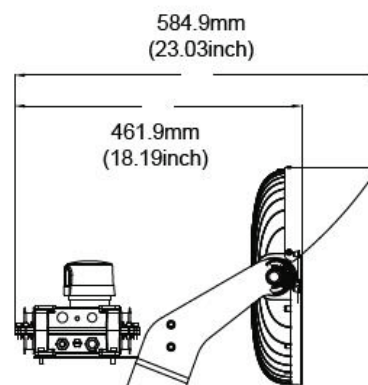
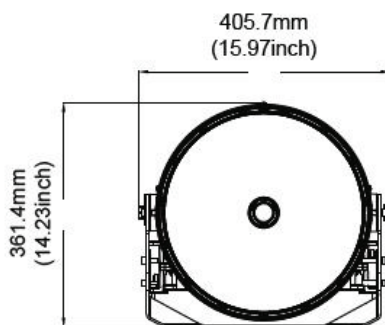

## Product Specifications

Product Name	LED Sport Light
Light Type	SZ-SP600WH-25-5000K
Dimension	23.03*15.97*14.23"

## Technical Characteristic

Color temperature	5000K, Optional:5700K
CRI	>70
Lumen	108000LM
Lumen Efficacy	180LM/W
Input Power	600W
Viewing Angle	25°, Optional:15°/40°/60°
Input Voltage	277-480V 50/60Hz, Optional:120-277V, 120-347V
Driver model	SOSEN Brand driver, (0-10Vdc Dimmer, Surge-protective 10KV)
PF	>0.9
Waterproof Rating	IP65

## Materials

LED Type	LUMILEDS 5050
LED QTY	270PCS
Housing	Aluminum(ADC12)
Housing color	Grey or Black
Operating Temperature	-40°C TO 45°C
Operating Humidity	10%-90% RH
Storage Temperature	-40°C TO 80°C

## Others

Storage Humidity	10%-95%
Application	Outdoor
Safety Certification	UL
Warranty Time	5 Years

## Light Distribution Testing Parameters

### LUMINAIRE PHOTOMETRIC TEST REPORT

Test:U:119.58V I:5.2714A P:629.13W PF:0.9981 Freq:60.01Hz		
UTHDi:0.80% ITHDi:3.34% KDisp:0.0000 Lamp Flux:116996x1 lm		
NAME: SZ-SP600WH-25-5000K	TYPE:	WEIGHT:
SPEC.: 277V	DIM.: 0.345	SERIAL No.:
MFR.:	SUR.: 0.345	Shielding Angle:

DATA OF LAMP		PHOTOMETRIC DATA			
MODEL	SZ-SP600WH-25-5000K	Imax (cd)	325147	S/MH (C0/180)	0.46
NOMINAL POWER (W)	600	LOR (%)	100.0	S/MH (C90/270)	0.48
RATED VOLTAGE (V)	120	TOTAL FLUX (lm)	116996	$\eta$ UP, DN (C0-180)	1.2, 45.3
NOMINAL FLUX (lm)	116996	CIE CLASS	DIRECT	$\eta$ UP, DN (C180-360)	1.2, 52.4
LAMPS INSIDE	1	$\eta$ up (%)	2.3	CIBSE SHR NOM	0.00
TEST VOLTAGE (V)	120	$\eta$ down (%)	97.7	CIBSE SHR MAX	0.30

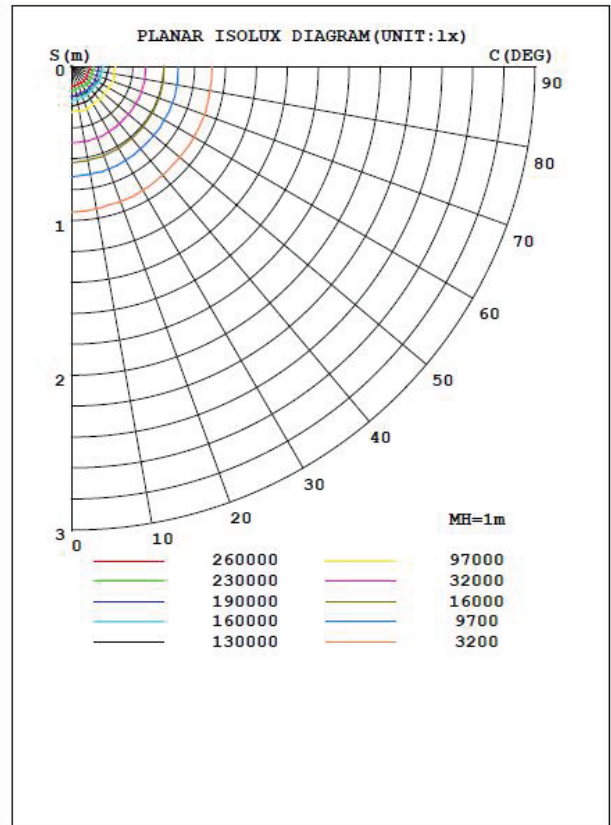
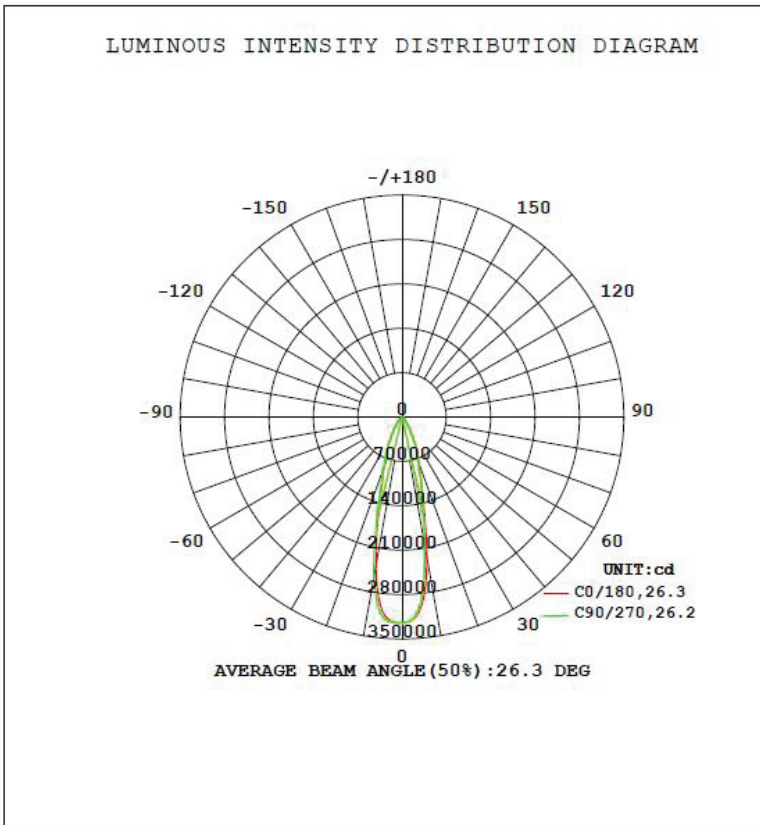

## Package

Model	Net Weight	Size	Qty/Carton	Weight/Carton
SZ-SP600WH-25-5000K	10.3KG	18.23*17.17*13.74"	1	13.61KG

**Product structure characteristics**

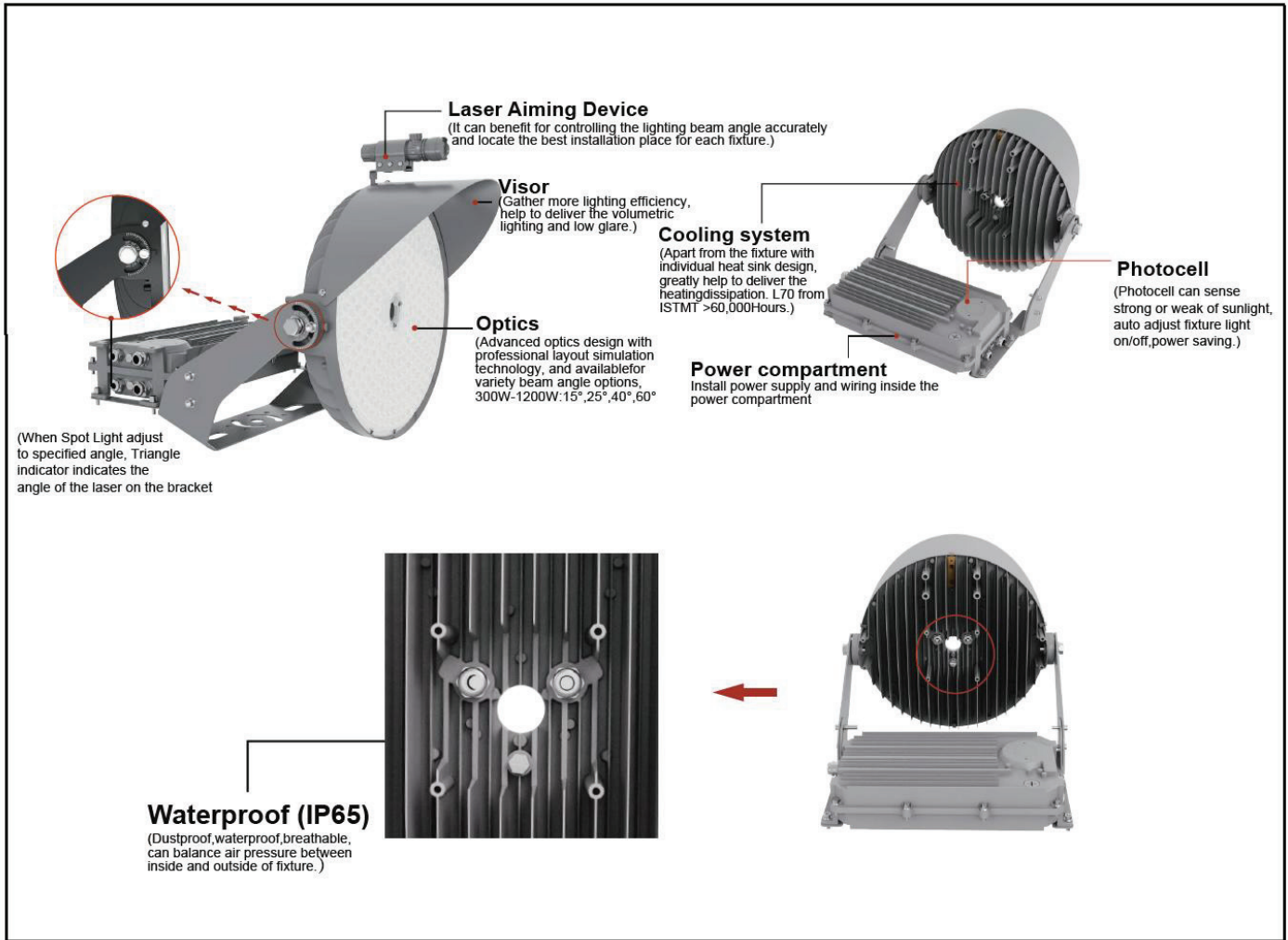

**Installation Diagram (optional)**

1. The entire lamp is directly fixed on the lamp poles.

2. The lamp body and power box can also be installed separately.

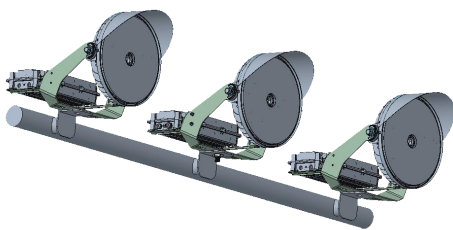

Install lighting fixtures on lamp posts.



Install a power box inside the distribution box.



## INSTALLATION INSTRUCTION

### Cautions:

- 1 Can not use the electric generator to test the LED lamp.
- 2 Please abide by related country, regional and local law and regulations when install this fixture.
- 3 To avoid electrical shock and damage, please do not install the lights in raining days.

### Notices:

- 1 To prevent from electric shock or fire risk, the installation must be conducted by operator who have professional electrical knowledge.
- 2 Please wear gloves to avoid injury before installing lamps.
- 3 During or after installation, if there are situations such as smoke, fire in the wires or lamps, please turn off the power immediately and notify relevant personnel of an overhaul.

### Installation - surface mounting:

1. Please find a professional to install the LED sports light.
2. lamp installation and wiring must be operated in case of power failure.
3. Do not disassemble any part of the fixing device.
4. Please do not use corrosive solution to clean the LED sports light. Please use a dry rag.
5. Please refer to the lamp label for product specifications.

### Installation Instruction:

1. Make the bracket face aim to the installation hole, put on the flat washer, spring washer and screw bolt, screw the nut from bottom to top.

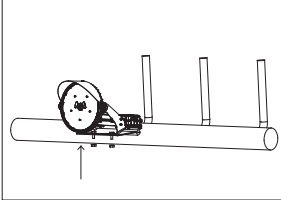

2. Fasten the screw nut clockwise with a wrench.

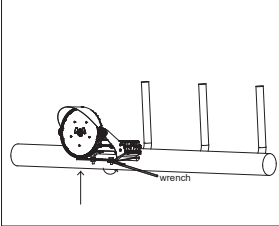

3. Loosen the bolt and screw on both side of light by using wrench and hex driver, rotate the light to the proper angle and fasten the screws.

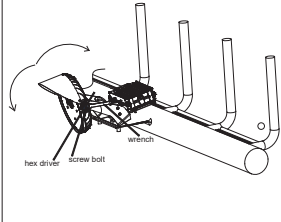

4. Wiring Diagram: Input wire (three cores): black, white, green. Dimming wires: (two cores): purple, pink.

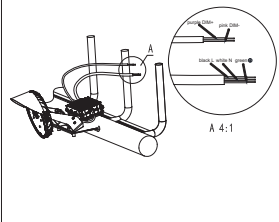

### Function of power Selective

1. Before installation, use a Phillips screwdriver to unscrew the plug on the power compartment counterclockwise.

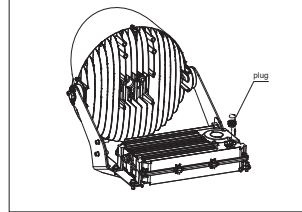

2. According to the identification, customers can choose the power dip switch and dial to the desired power.

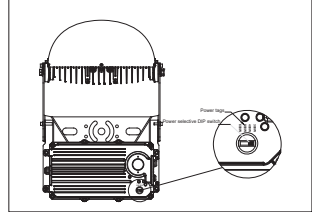

3. Set the power, tighten the plug clockwise, and complete the power selection.

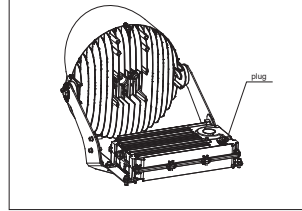

### Laser Sighting Device Installation Instruction

1. Put the laser sighting device into the laser diode.

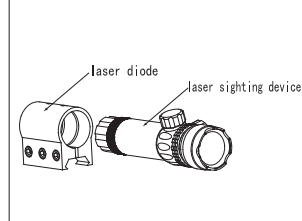

2. Choosing the hexagon wrench, to light the middle screw of the laser diode.

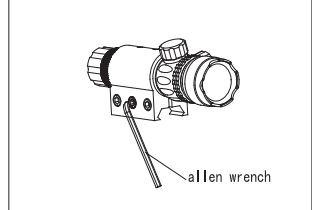

3. Snap the side of the "L" bracket that is without slot into the laser diode snap slot.

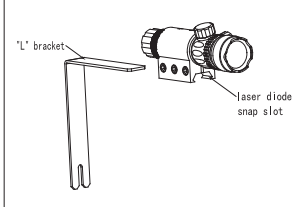

4. Put the "L" bracket into slot of laser diode, and use hexagon wrench to fix the rest screw on each side.

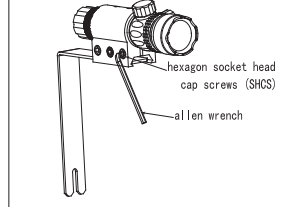

5. Insert the assembled laser sighting equipment into the slot of the power supply cover.

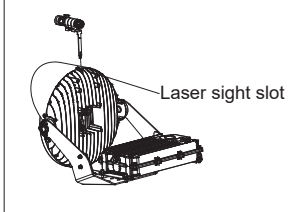

6. Press the wireless laser button, the laser will be constant on. If it is a wired button, then need to long presee until it is on. Laser will turn off when release the button.

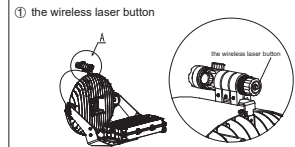

- ② the wired laser button

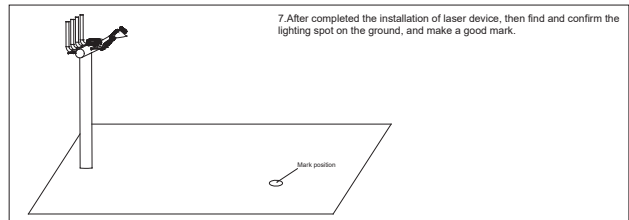
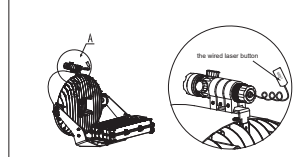

7. After completed the installation of laser device, then find and confirm the lighting spot on the ground, and make a good mark.

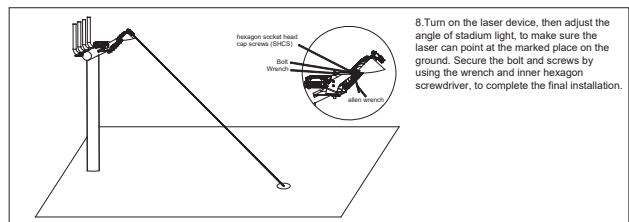

8. Turn on the laser device, then adjust the angle of stadium light, to make sure the laser can point at the marked place on the ground. Secure the bolt and screws by using the wrench and inner hexagon screwdriver, to complete the final installation.

### Warning

1. Before starting use of the light, please check if the light was damaged during transportation. If any damage shown, please do not install or use it.
2. The products itself and all its components should not be mechanically stressed.
3. Installation must not damage or destroy conducting paths or other parts of the product.
4. Installation of LED product (with power supplies) needs to be made with regard to all applicable electrical and safety standards. Only qualified personnel should be allowed to perform installations.
5. Correct electrical polarity needs to be observed. Wrong polarity may damage or destroy the LED products.
6. If fixing on metallic or otherwise conductive surfaces, there should be an electrical insulator between the product and the mounting surface.
7. All LEDs are static sensitive. Precautions should be taken to ensure that LEDs are well protected from ESD during handling, even though the chips are safe in low static-electric discharge events.
8. DO NOT operate LEDs in reverse bias.
9. Damaged by corrosion will not be honored as a materials defect claim. It is the user's responsibility to provide suitable protection against corrosive agents such as moisture and condensation and other harmful elements.
10. Identify Positive (+) and negative (-) outputs of the power supply by using a multimeter.
11. Electrical connection should be in a dry area unless adequately sealed.
12. This product series emits high light output. DO NOT look directly into the light emitting area. Direct exposure to the light over an extended time period may harm eyes.
13. If the external flexible cable or cord of this luminaire is damaged, it shall be exclusively replaced by the manufacturer or his service agent or a similar qualified person in order to avoid a hazard.

1. MIN 105°C SUPPLY CONDUCTORS / LES FILS D'ALIMENTATION 105°C MIN
2. SUITABLE FOR WET LOCATIONS / CONVIENT AUX EMPLACEMENTS MOUILLÉS
3. CAUTION - RISK OF FIRE. CAUTION - RISK OF SHOCK.
4. ATTENTION - RISQUE D'INCENDIE. ATTENTION - RISQUE DE CHOC.
5. THIS PRODUCT MUST BE INSTALLED IN ACCORDANCE WITH THE APPLICABLE INSTALLATION CODE BY A PERSON FAMILIAR WITH THE CONSTRUCTION AND OPERATION OF THE PRODUCT AND THE HAZARDS INVOLVED. CE PRODUIT DOIT ÊTRE INSTALLÉ SELON LE CODE D'INSTALLATION PERTINENT, PAR UNE PERSONNE QUI CONNAÎT BIEN LE PRODUIT ET SON FONCTIONNEMENT AINSI QUE LES RISQUES INHÉRENTS.

### Correct Disposal of this product

This marking indicates that this product should not be disposed with other household wastes throughout the EU. To prevent possible harm to the environment or human health from uncontrolled waste disposal, recycle it responsibly to promote the sustainable reuse of material resources. To return your used device, please use the return and collection systems or contact the retailer where the product was purchased. They can take this product for environmental safe recycling.