

Features :

- Input Voltage:120-277VAC 50/60Hz.
- ETL & DLC 5.1 certified.
- 130lm/W high lumen efficacy, 80+ CRI.
- 0-10V Dimmable LED driver.
Adjustable CCT: 3500K/4000K/5000K/5700K/6500K
Adjustable Power: 15W/20W/25W/30W/40W.
- High efficiency LM80 SMD LEDs.
- Designed for 50,000 hours lifetime.
- Instant startup, soft light, no glare, no noise.
- Easy for installation.



Application:

- ◆ Factory, offices .
- ◆ Living room, clubs, lobbies.
- ◆ Supermarkets, school, hotel.
- ◆ Exhibitions, etc..



Product Dimension:

Unit:inch

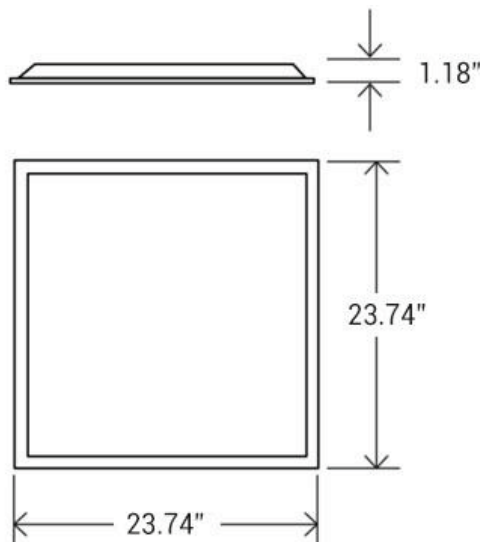

Specifications

LED Panel Light

Model:	SZ-PL22-A40W-CCT
Wattage:	15W/20W/25W/30W/40W
CCT:	3500K/4000K/5000K/5700K/6500K
Input Voltage:	120-277VAC 50/60hz
Power Factor:	>0.9
Efficacy:	125LM/W
CRI:	>80
THD:	<20
Dimmable:	Yes
Dimensions:	2*2FT
Warranty:	5 years
Beam Angle:	120°
Operating Temperature:	-20°C to 40°C
IP Grade:	IP40
Certification:	ETL, DLC5.1
Optional Accessory	Emergency Driver:Max 8W, Recharge time: \geq 24Hrs, Discharge time :90minutes. Sensor: PIR Sensor or Microwave Sensor.

Package

Size	Qty/Carton	Gross Weight	Net Weight
25.4*8.86*25.6"	6	11.14Kg	10.2Kg

Installation instructions

Recessed installation

2*2FT Panel

1. Replace existing lighting fixture from ceiling with LED Panel.

2. Use the protective brackets for the sake of safety.

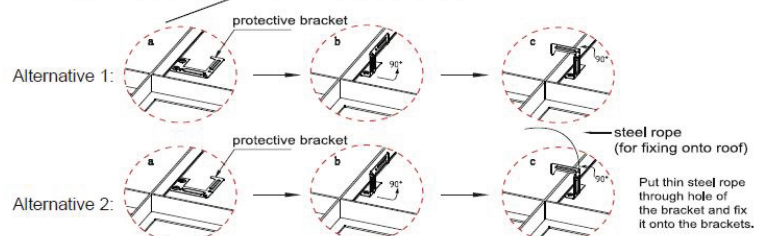
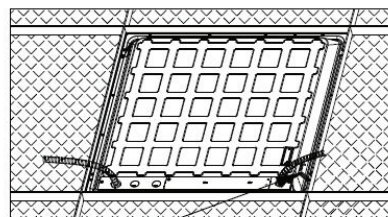
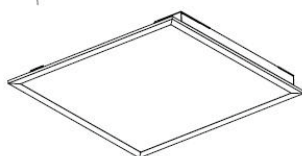
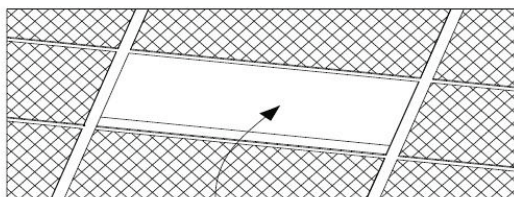

Installation Guide

1. Unscrew the driver cover.

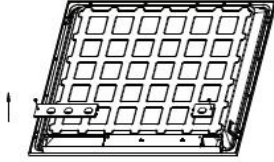

2. Connect the conduit to the driver box.

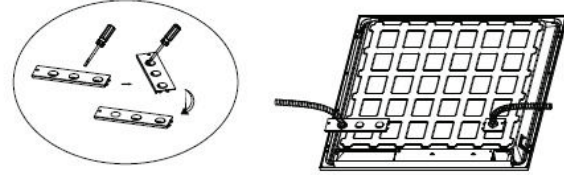

3. Connect other wires separately.

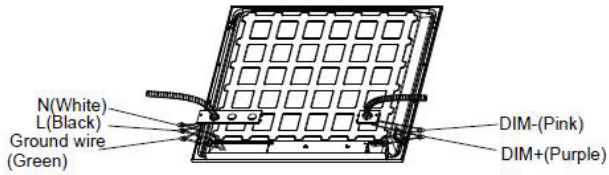

4. Put back the driver cover and fix it by screw.
Select adjustable power and color temperature.

