

Under Cabinet Light

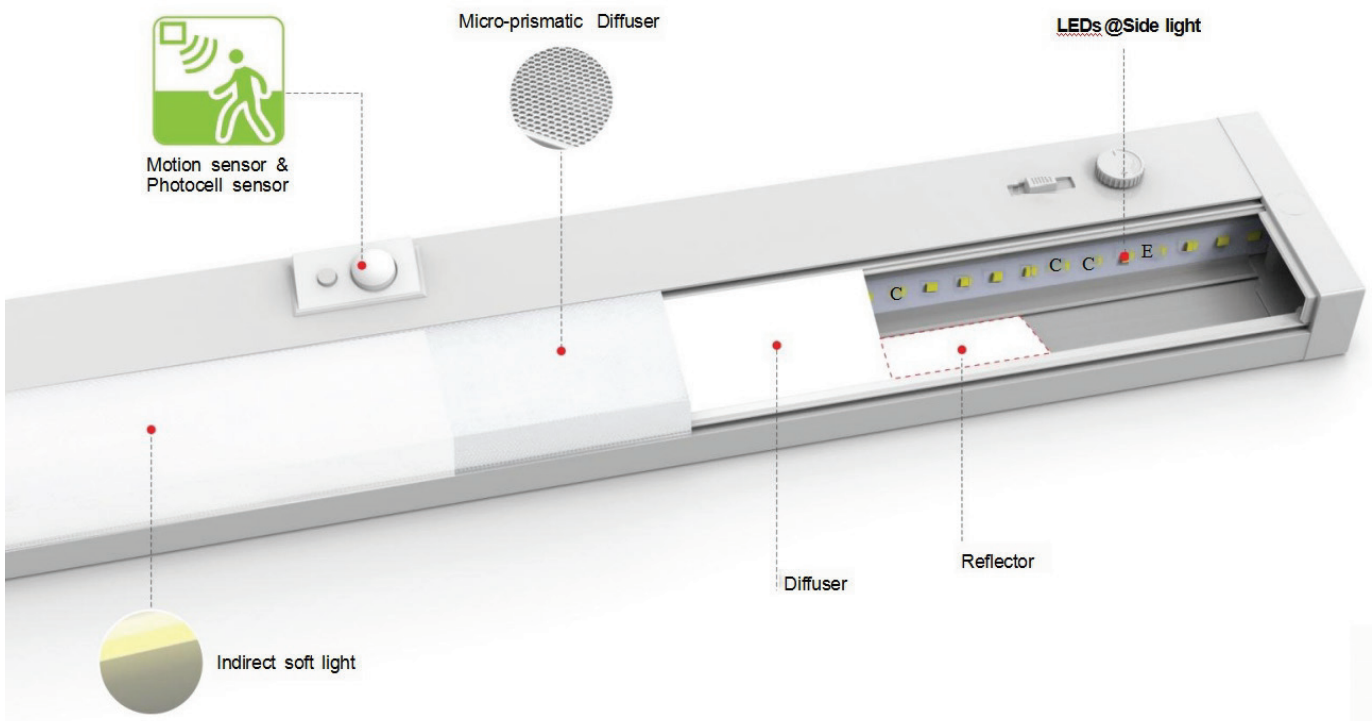

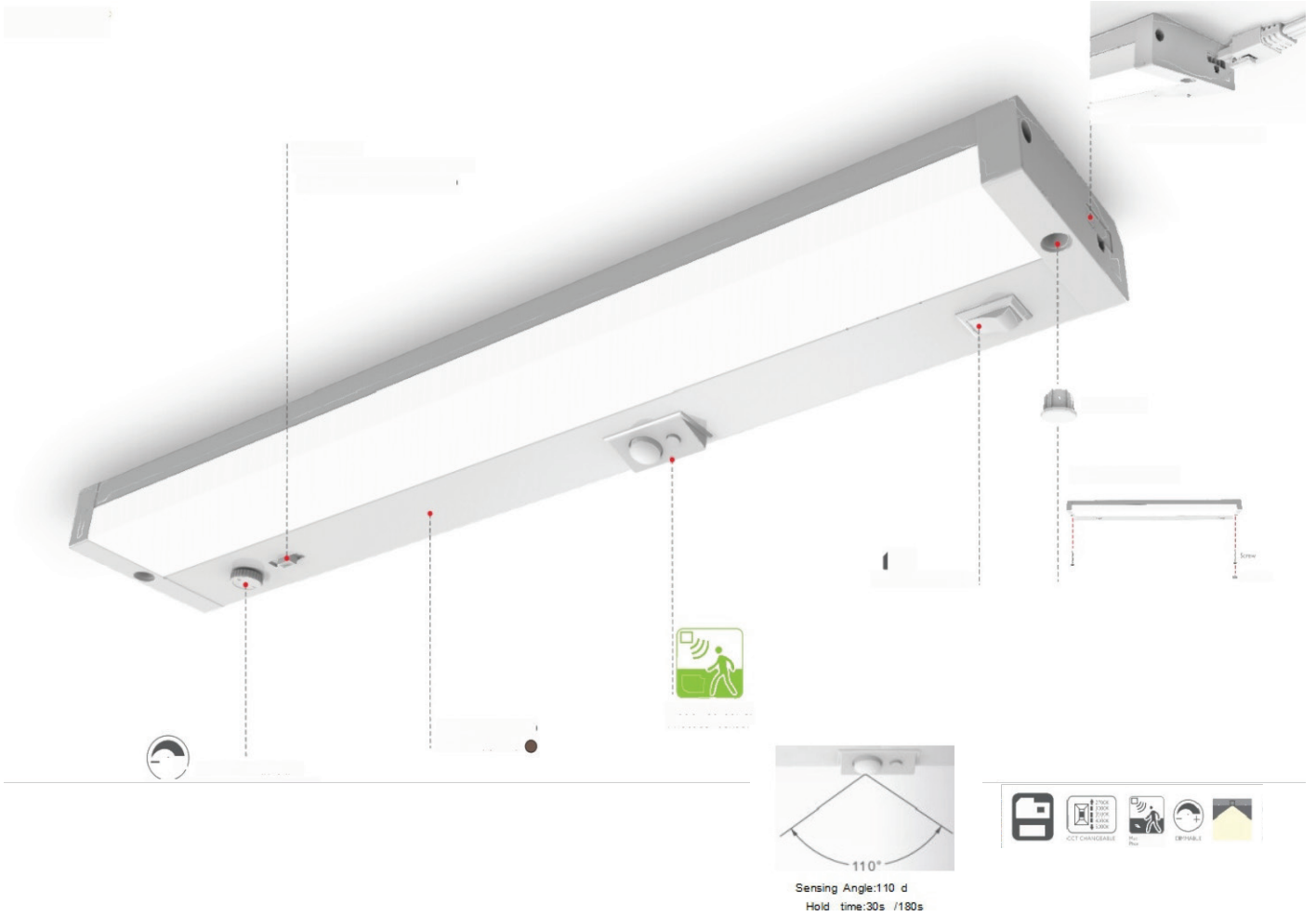

12inch/16inch/18inch/24inch/32inch/40inch

Product Size:	12inch/16inch/18inch/24inch/32inch/40inch
Power (w):	6W/8W/9W/12W/16W/20W
Voltage:	100-130VAC
Operating Temperature:	-20°C~40°C
Warranty:	5 years
CCT Color:	2700K,3000K,3500K,4000K,5000K
Ra	Ra>80/90
Light Efficacy (lm/w):	>80lm/W
Beam Angle(°):	110
Product Type:	Category I
Product Color:	White RAL9003 <input type="radio"/> Bronzer (optiona) <input type="radio"/>

Product display

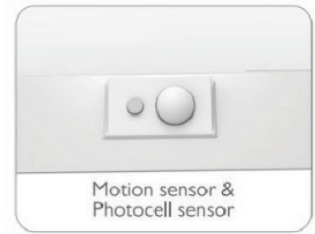
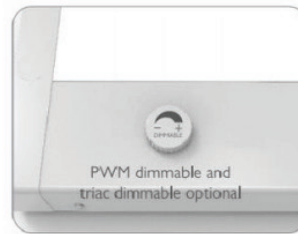
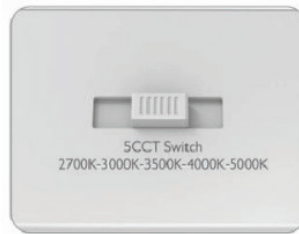

Accessories

AC Input Cable



Junction connector



Product Specifications: 12inch

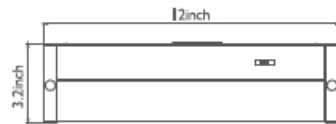

Front View



Side View

Item No.	Size:	Watt	Voltage	Lumens	Adjustable CCT	PF	Function
SZ-UC6W12-CCT	12*3.2*1.25 inch	6W	AC100-130V	480-540Lm	2700K/3000K/ 3500K/4000K/5000K	>0.9	Switchon/off
SZ-UC6W12-D-CCT							Triac Dimmable, Switch on/off
SZ-UC6W12-PWM-CCT							Dimmable,Switchon/off

Product Specifications: 16inch

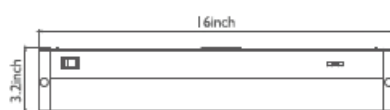

Front View



Side View

Item No.	Size:	Watt	Voltage	Lumens	Adjustable CCT	PF	Function
SZ-UC8W16-CCT	16*3.2*1.25 inch	8W	AC100-130V	680-760Lm	2700K/3000K/ 3500K/4000K/5000K	>0.9	Switchon/off
SZ-UC8W16-D-CCT							Triac Dimmable, Switch on/off
SZ-UC8W16-PWM-CCT							Dimmable,Switchon/off

Product Specifications: 18inch

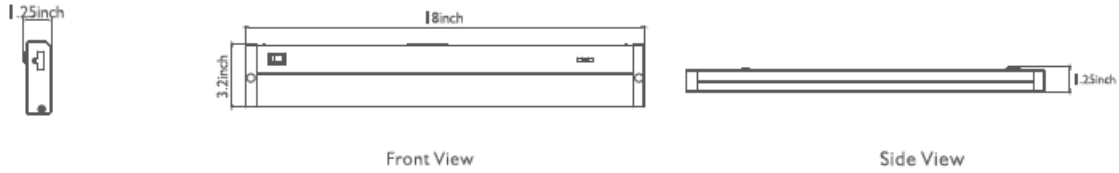

Item No.	Size:	Watt	Voltage	Lumens	Adjustable CCT	PF	Function
SZ-UC9W18-CCT	18*3.2*1.25 inch	9W	AC100-130V	765-855Lm	2700K/3000K/ 3500K/4000K/5000K	>0.9	Switchon/off
SZ-UC9W18-D-CCT							Triac Dimmable, Switch on/off
SZ-UC9W18-PIR-D-CCT							PIR+Light Sensor, Triac Dimmable,Switchon/off
SZ-UC9W18-PWM-CCT							Dimmable,Switchon/off

Product Specifications: 24inch



Item No.	Size:	Watt	Voltage	Lumens	Adjustable CCT	PF	Function
SZ-UC12W24-CCT	24*3.2*1.25 inch	12W	AC100-130V	1020-1140Lm	2700K/3000K/ 3500K/4000K/5000K	>0.9	Switchon/off
SZ-UC12W24-D-CCT							Triac Dimmable, Switch on/off
SZ-UC12W24-PWM-CCT							Dimmable,Switchon/off

Product Specifications: 32inch

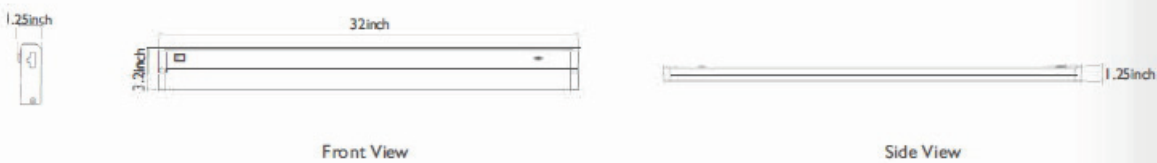

Item No.	Size:	Watt	Voltage	Lumens	Adjustable CCT	PF	Function
SZ-UC16W32-CCT	32*3.2*1.25 inch	16W	AC100-130V	1440-1520Lm	2700K/3000K/ 3500K/4000K/5000K	>0.9	Switchon/off
SZ-UC16W32-D-CCT							Triac Dimmable, Switch on/off
SZ-UC16W32-PWM-CCT							Dimmable,Switchon/off

Product Specifications: 40inch

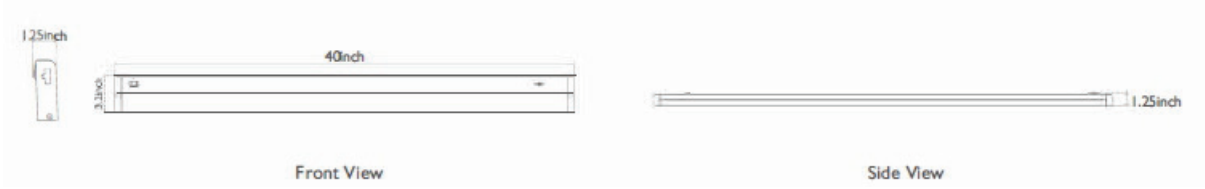

Item No.	Size:	Watt	Voltage	Lumens	Adjustable CCT	PF	Function
SZ-UC20W40-CCT	40*3.2*1.25 inch	20W	AC100-130V	1800-1900Lm	2700K/3000K/ 3500K/4000K/5000K	>0.9	Switchon/off
SZ-UC20W40-D-CCT							Triac Dimmable, Switch on/off
SZ-UC20W40-PWM-CCT							Dimmable,Switchon/off

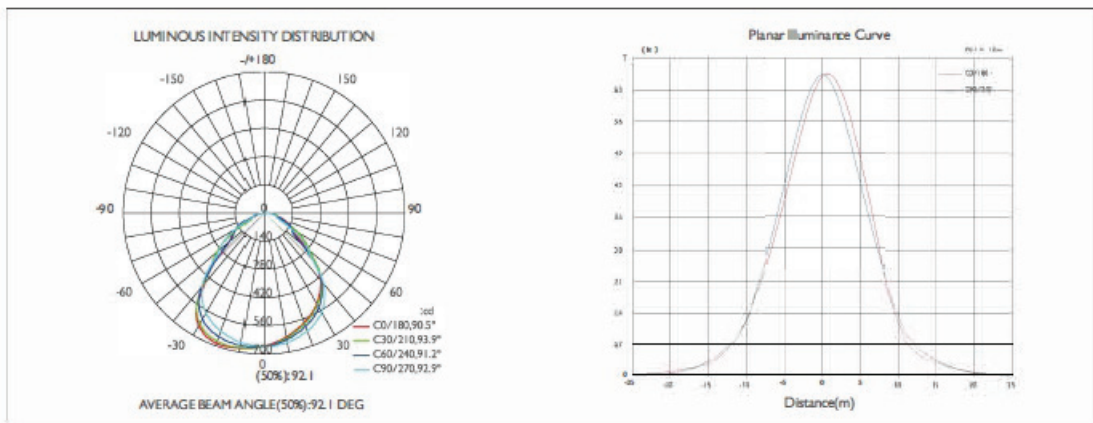

Installation 1

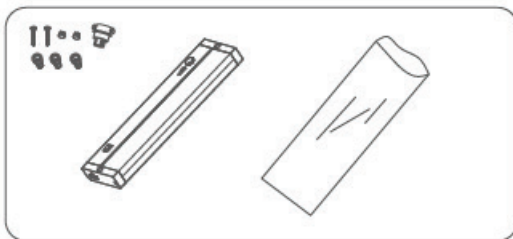

1. Product List

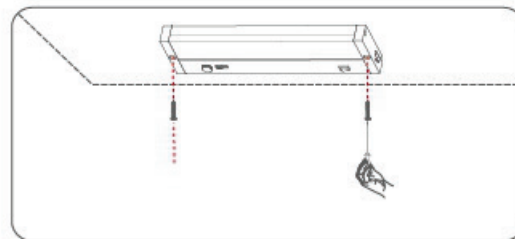

2. Use screws to secure the lamp body.

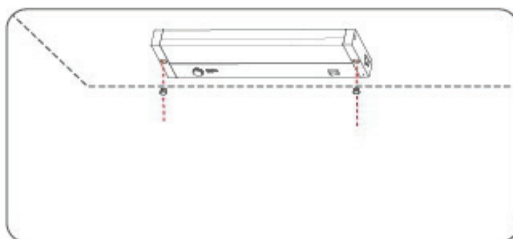

3. Seal-screw hole.

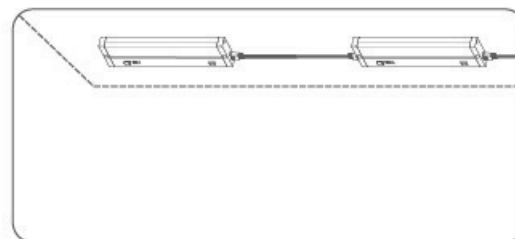

4. The installation is complete.

Installation 2

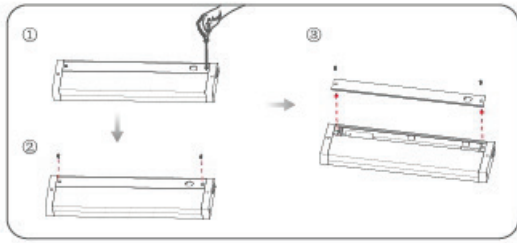

1. Use the tool to unscrew and remove the back cover.

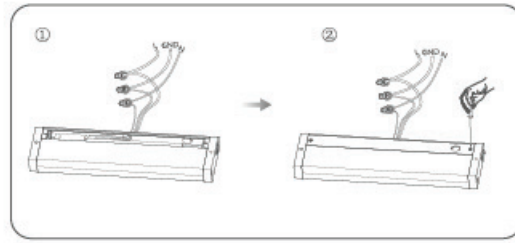

2. ① Connect -L/N/GND to the mains
② Screw the back cover

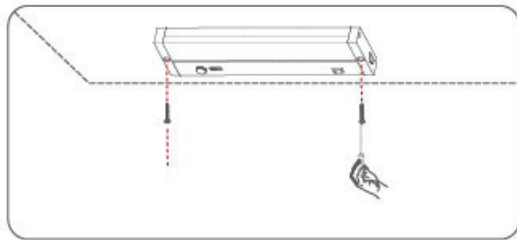

3. Use screws to secure the lamp body.

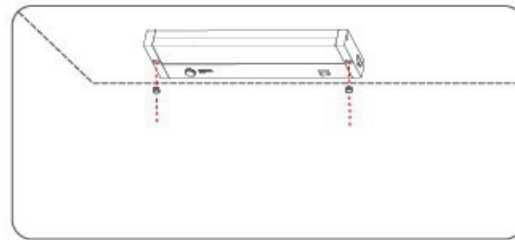

4. Seal-screw hole.

Plug-in Installation

Remark: Sensor function will be disabled with the plugged-in wiring from fixture side. Other functions include 5CCT, on/off switch are normal

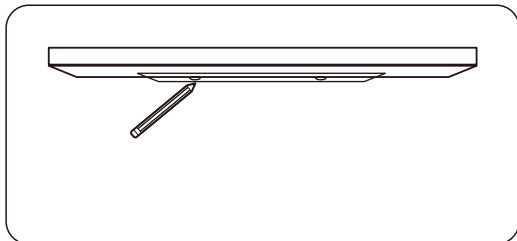

1. Position the fixture Find the desired place and make a mark

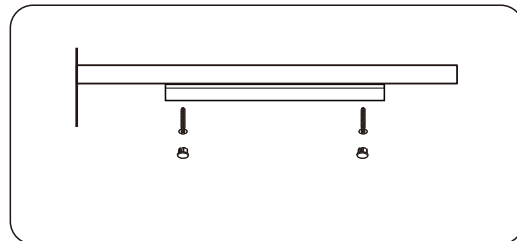

2. Install the cabinet light to the right mark place using the two screws.
And cover the screw holes with Screw cap

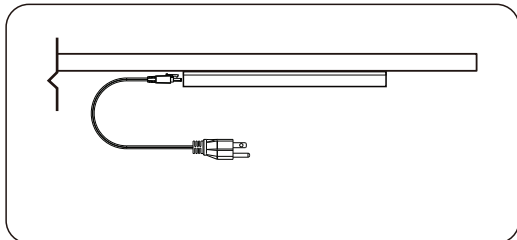

Plug in the electrical Power Cord to the fixture;
Multiple cabinet light fixture can be linked together with the linking cord or End to End connector,
After all installation/link finished, cover the end fixture connector hole by the End cup

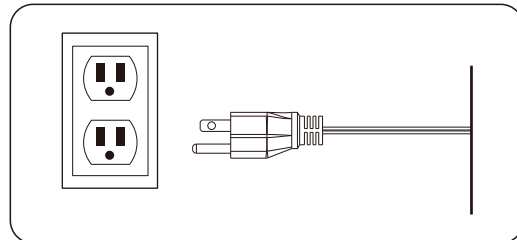

Connect the plug to the socket

Package

Carton Dimensions

INNER BOX

Box Dimensions:

- 12" L19.7 x W3.6 x H1.42 inch
- 16" L23.2 x W3.6 x H1.42 inch
- 18" L25.2 x W3.6 x H1.42 inch
- 24" L31.2 x W3.6 x H1.42 inch
- 32" L39.2 x W3.6 x H1.42 inch
- 40" L47.2 x W3.6 x H1.42 inch

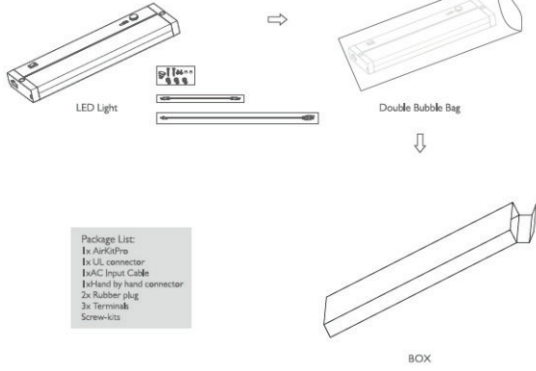

Package List:
 1x AirKitPro
 1x UL connector
 1x AC Input Cable
 1x Hand by hand connector
 2x Rubber plug
 3x Terminals
 Screw-kits

CARTON

Carton Dimensions:

- 12" L19.8 x W14.9 x H7.9 inch
Qty / Carton : 20 PCS
- 16" L23.8 x W12.2 x H7.9 inch
Qty / Carton : 16 PCS
- 18" L25.8 x W12.2 x H7.9 inch
Qty / Carton : 16 PCS
- 24" L31.8 x W12.2 x H7.9 inch
Qty / Carton : 16 PCS
- 32" L39.8 x W9.3 x H7.9 inch
Qty / Carton : 12 PCS
- 40" L47.8 x W7.9 x H7.9 inch
Qty / Carton : 10 PCS

