

Features :

- Replaces legacy CFL, HID or incandescent down lights.
- UL, certified.
- Provides comfortable diffused light with no dark spots.
- Dimmable to 10% with a wide array of dimmers.
- 3CCT selectable version optional
- High efficiency LM80 SMD LEDs.
- Designed for 50,000 hours lifetime.
- Clips for secure installation onto existing ceilings.
- Pre-wired with poke-in connectors for easy installation.

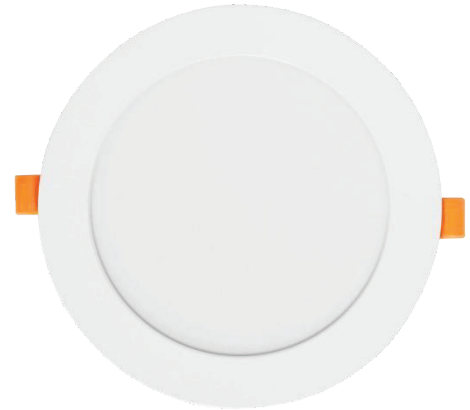

Application:

- ◆ Residential.
- ◆ Property management.
- ◆ Office, Multi-family.
- ◆ Hospitality, Healthcare etc..



Product Dimension:

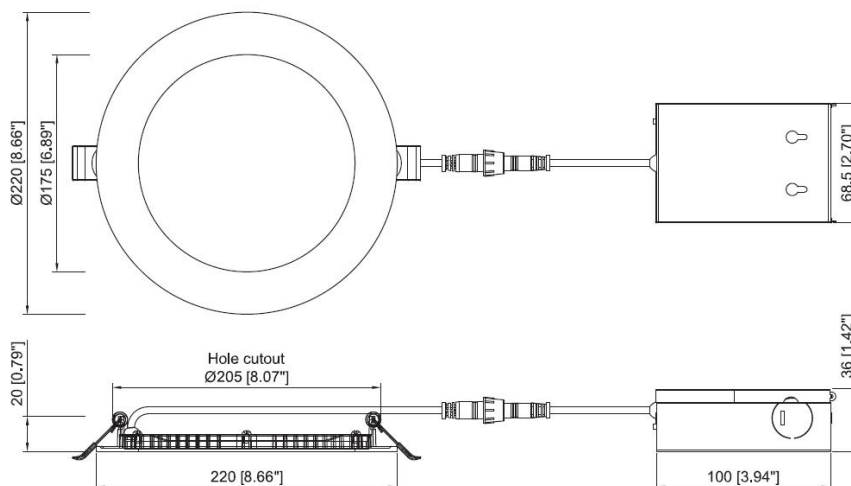

Specifications

LED Slim Panel Light

Model:	SZ-DL24W8-SP (3CCT)
Wattage:	24W
Size:	8 inch
CCT Selectable:	4000K/5000K/6000K
CRI:	80
Beam Angle:	120°
Lumens:	>2100LM
PF:	>0.9
Driver:	120V 50/60Hz Triac dimming
Certification:	UL
Warranty:	5 years

Package

Size	Qty/Carton	Gross Weight
18.7*9.25*18.9"	24	13Kg

Installation instructions

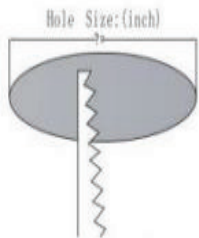

Step 1:
Drill hole

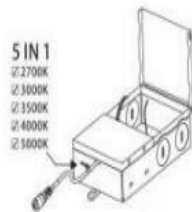

Step 2:
Select CCT

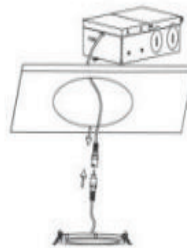

Step 3:
Connect the cable

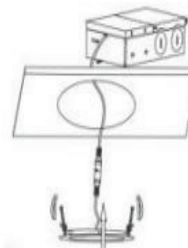

Step 4:
Install the fixture

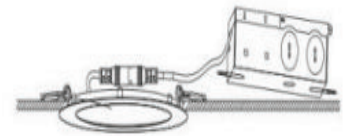

Step 5:
Done